

**WP-9 Series Air Cooled TIG Torch**

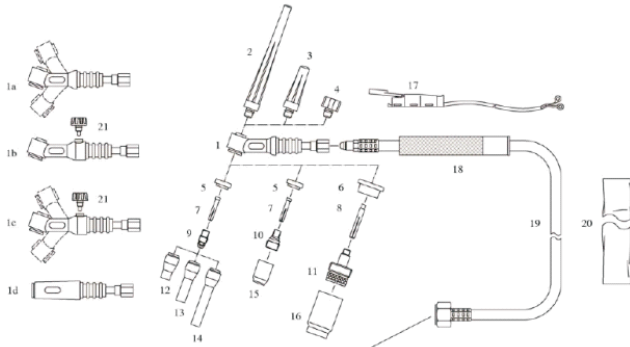

**Technical Data**  
 Rating: 125A DC  
 80AAC  
 Duty Cycle: 60%  
 Electrodes: 0.5~2.4mm

We can supply any cable termination according to customer request  
 The normal cable termination styles see Page 3-4

NO.	DESCRIPTION	PART NO.
	WP-9 Torch (Gas and Cable Whole)	WP-9-1 (4m)
	WP-9 Torch (Gas and Cable Whole)	WP-9-1 (8m)
	WP-9 Torch (Gas and Cable Separate)	WP-9-2 (4m)
	WP-9 Torch (Gas and Cable Separate)	WP-9-2 (8m)
1	Torch Body	WP-9
1a	Torch Body (Flexible)	WP-9F
1b	Torch Body (Valve)	WP-9V
1c	Torch Body (Flexible and Valve)	WP-9FV
1d	Torch Body (Pencil)	WP-9P
2	Long Back Cap	41V24
3	Medium Back Cap	41V35
4	Short Back Cap	41V33
5	Gasket	598882
6	Large Dia. Gas Lens Insulator	54N63-20
7	Collet, 0.5mm	13N20
7	Collet, 1.0mm	13N21
7	Collet, 1.6mm	13N22
7	Collet, 2.0mm	13N22M
7	Collet, 2.4mm	13N23
8	Large Dia. Gas Lens Collet, 0.5mm	13N20L
8	Large Dia. Gas Lens Collet, 1.6mm	13N22L
8	Large Dia. Gas Lens Collet, 2.4mm	13N23L
9	Collet Body, 0.5mm	13N25
9	Collet Body, 1.0mm	13N26
9	Collet Body, 1.6mm	13N27
9	Collet Body, 2.0mm	13N27M
9	Collet Body, 2.4mm	13N28
10	Gas Lens Body, 0.5mm	45V41
10	Gas Lens Body, 1.0mm	45V42
10	Gas Lens Body, 1.6mm	45V43
10	Gas Lens Body, 2.0mm	45V43M
10	Gas Lens Body, 2.4mm	45V44
11	Large Dia. Gas Lens Body	45V0204S
11	Large Dia. Gas Lens Body, 1.6mm	45V116S
11	Large Dia. Gas Lens Body, 2.4mm	45V64S
12	Ceramic Nozzle, 6mm	13N08
12	Ceramic Nozzle, 8mm	13N09
12	Ceramic Nozzle, 10mm	13N10
12	Ceramic Nozzle, 11mm	13N11
12	Ceramic Nozzle, 13mm	13N12

NO.	DESCRIPTION	PART NO.
12	Ceramic Nozzle, 16mm	13N13
13	Long Ceramic Nozzle, 5mm	796F70
13	Long Ceramic Nozzle, 6mm	796F71
13	Long Ceramic Nozzle, 8mm	796F72
13	Long Ceramic Nozzle, 10mm	796F73
14	Extra Long Ceramic Nozzle, 5mm	796F74
14	Extra Long Ceramic Nozzle, 6mm	796F75
14	Extra Long Ceramic Nozzle, 8mm	796F76
14	Extra Long Ceramic Nozzle, 10mm	796F77
15	Ceramic Nozzle, 6mm	53N58
15	Ceramic Nozzle, 8mm	53N59
15	Ceramic Nozzle, 10mm	53N60
15	Ceramic Nozzle, 11mm	53N61
15	Ceramic Nozzle, 13mm	53N61S
16	Large Dia. Ceramic Nozzle, 10mm	57N75
16	Large Dia. Ceramic Nozzle, 13mm	57N74
16	Large Dia. Ceramic Nozzle, 16mm	53N88
16	Large Dia. Ceramic Nozzle, 19mm	53N87
17	Switch (With Wire)	
18	Handle	105Z55
19	Cable Assembly	
20	Cable Assembly Cover	
21	Valve Stem	VS-2

**WP-9,WP-9F,WP-9V,WP-9FV Cable Terminations (Cable and Gas Whole)**

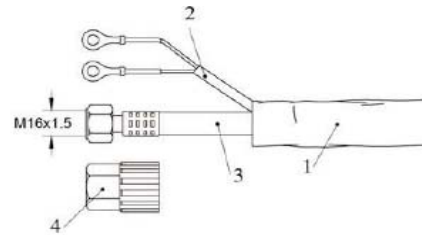

NO.	DESCRIPTION
1	Cable Assembly Cover, For 4m(12.5ft), Rubber/Jean Cable Assembly Cover, For 8m(25ft), Rubber/Jean
2	Control Wire
3	Cable 10mm <sup>2</sup> , 4m(12.5ft) Cable 10mm <sup>2</sup> , 8m(25ft)
4	Nut Cup(SW19)

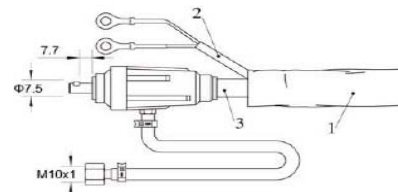

NO.	DESCRIPTION
1	Cable Assembly Cover, For 4m(12.5ft), Rubber/Jean Cable Assembly Cover, For 8m(25ft), Rubber/Jean
2	Control Wire
3	Cable 10mm <sup>2</sup> , 4m(12.5ft) Cable 10mm <sup>2</sup> , 8m(25ft)

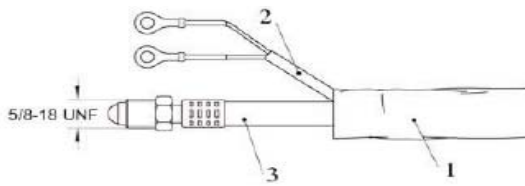

NO.	DESCRIPTION
1	Cable Assembly Cover, For 4m(12.5ft), Rubber/Jean Cable Assembly Cover, For 8m(25ft), Rubber/Jean
2	Control Wire
3	Cable 10mm <sup>2</sup> , 4m(12.5ft) Cable 10mm <sup>2</sup> , 8m(25ft)

**WP-9,WP-9F,WP-9V,WP-9FV Cable Terminations (Cable and Gas Separate)**

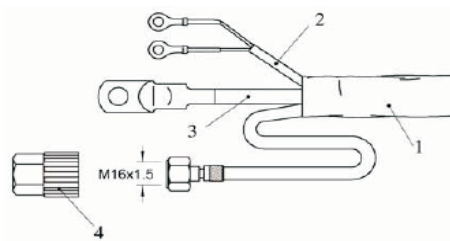

NO.	DESCRIPTION
1	Cable Assembly Cover, For 4m(12.5ft), Rubber/Jean Cable Assembly Cover, For 8m(25ft), Rubber/Jean
2	Control Wire
3	Cable 16mm <sup>2</sup> , 4m(12.5ft) Cable 16mm <sup>2</sup> , 8m(25ft)
4	Nut Cup(SW19)

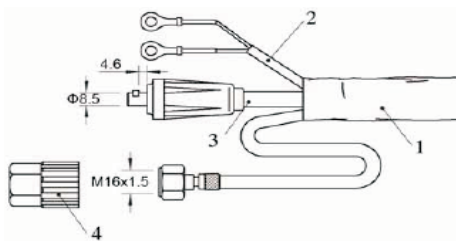

NO.	DESCRIPTION
1	Cable Assembly Cover, For 4m(12.5ft), Rubber/Jean Cable Assembly Cover, For 8m(25ft), Rubber/Jean
2	Control Wire
3	Cable 16mm <sup>2</sup> , 4m(12.5ft) Cable 16mm <sup>2</sup> , 8m(25ft)
4	Nut Cup(SW19)

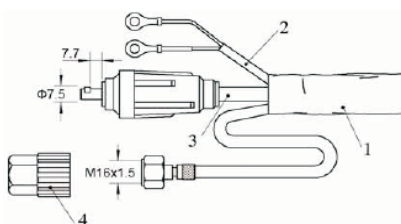

NO.	DESCRIPTION
1	Cable Assembly Cover, For 4m(12.5ft), Rubber/Jean Cable Assembly Cover, For 8m(25ft), Rubber/Jean
2	Control Wire
3	Cable 16mm <sup>2</sup> , 4m(12.5ft) Cable 16mm <sup>2</sup> , 8m(25ft)
4	Nut Cup(SW19)

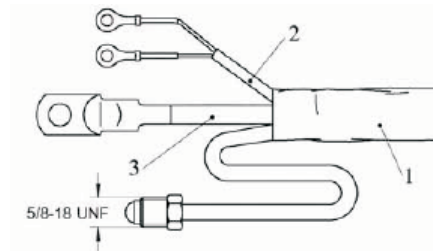

NO.	DESCRIPTION
1	Cable Assembly Cover, For 4m(12.5ft), Rubber/Jean Cable Assembly Cover, For 8m(25ft), Rubber/Jean
2	Control Wire
3	Cable 16mm <sup>2</sup> , 4m(12.5ft) Cable 16mm <sup>2</sup> , 8m(25ft)

Please indicate the length, cable termination, and cable cover type, when ordering complete torch

**WP-12 Series Water Cooled TIG Torch**

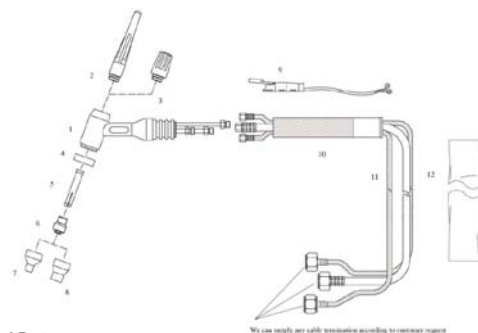

**Technical Data**  
 Rating: 500ADC  
 Duty Cycle: 100%  
 Electrodes: 1.6-6.4mm

NO.	DESCRIPTION	PART NO.
	WP-12 Torch	WP-12 (4m)
	WP-12 Torch	WP-12 (8m)
1	Torch Body	WP-12
2	Long Back Cap	56Y44
3	Short Back Cap	56Y45
4	Gasket	12NG
5	Collet, 1.6mm	85Z14
5	Collet, 2.4mm	85Z15
5	Collet, 3.2mm	85Z16
5	Collet, 4.0mm	85Z17
5	Collet, 4.8mm	85Z18
5	Collet, 6.4mm	85Z19

NO.	DESCRIPTION	PART NO.
6	Large Dia. Gas Lens Collet, All Size	11WP65
7	Ceramic Nozzle, 6mm	14N57
7	Ceramic Nozzle, 8mm	14N58
7	Ceramic Nozzle, 10mm	14N59
7	Ceramic Nozzle, 11mm	14N60
7	Ceramic Nozzle, 13mm	14N61
7	Ceramic Nozzle, 16mm	14N61-10
7	Ceramic Nozzle, 19mm	14N61-12
8	Extra Dia. Ceramic Nozzle, 10mm	57N75
8	Extra Dia. Ceramic Nozzle, 13mm	57N74
8	Extra Dia. Ceramic Nozzle, 16mm	53N88
8	Extra Dia. Ceramic Nozzle, 19mm	53N87
9	Switch (With Wire)	
10	Handle	85WP13
11	Cable Assembly	
12	Cable Assembly Cover	

**WP-17 Series Air Cooled TIG Torch**

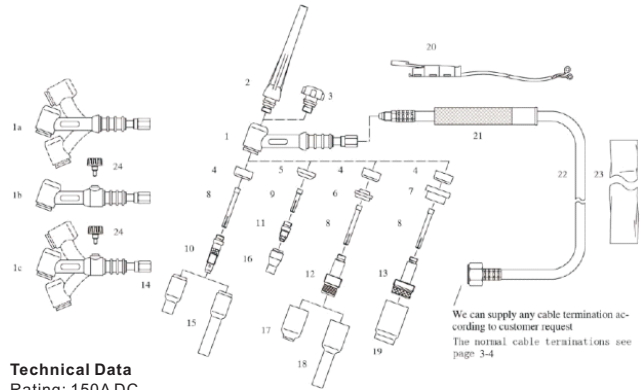

**Technical Data**  
 Rating: 150A DC  
 120AAC  
 Duty Cycle: 60%  
 Electrodes: 0.5-2.4mm

We can supply any cable termination according to customer request. The normal cable terminations see page 3-4

**WP12 Cable Terminations**

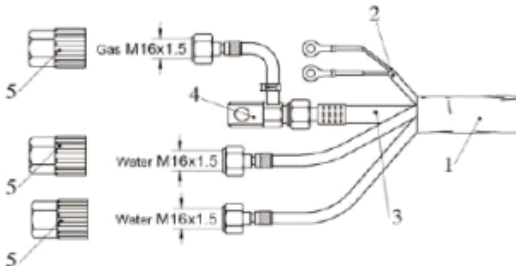

NO.	DESCRIPTION
1	Cable Assembly Cover, For 4m(12.5ft), Rubber/Jean
	Cable Assembly Cover, For 8m(25ft), Rubber/Jean
2	Control Wire
3	Cable 12mm <sup>2</sup> , 4m(12.5ft)
	Cable 12mm <sup>2</sup> , 8m(25ft)
4	Cable Adapter
5	Nut Cup(SW19)

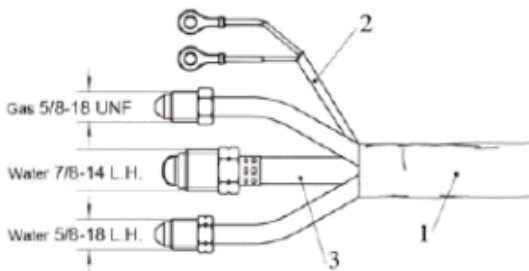

NO.	DESCRIPTION
1	Cable Assembly Cover, For 4m(12.5ft), Rubber/Jean
	Cable Assembly Cover, For 8m(25ft), Rubber/Jean
2	Control Wire
3	Cable 12mm <sup>2</sup> , 4m(12.5ft)
	Cable 12mm <sup>2</sup> , 8m(25ft)

Please indicate the length, cable termination, and cable cover type, when ordering complete torch

NO.	DESCRIPTION	PART NO.
	WP-17 Torch (Gas and Cable Whole)	WP-17-1 (4m)
	WP-17 Torch (Gas and Cable Whole)	WP-17-1 (8m)
	WP-17 Torch (Gas and Cable Separate)	WP-17-2 (4m)
	WP-17 Torch (Gas and Cable Separate)	WP-17-2 (8m)
1	Torch Body	WP-17
1a	Torch Body (Flexible)	WP-17F
1b	Torch Body (Valve)	WP-17V
1c	Torch Body (Flexible and Valve)	WP-17FV
2	Long Back Cap	57Y02
3	Short Back Cap	57Y04
4	Gasket	18CG
5	Stubby Gasket	18CG-20
6	Gas Lens Insulator	54N01
7	Large Dia. Gas Lens Insulator	54N63
8	Collet, 0.5mm	10N21
8	Collet, 1.0mm	10N22
8	Collet, 1.6mm	10N23
8	Collet, 2.0mm	10N23M
8	Collet, 2.4mm	10N24
9	Stubby Collet, 0.5mm	10N21S
9	Stubby Collet, 1.0mm	10N22S
9	Stubby Collet, 1.6mm	10N23S
9	Stubby Collet, 2.0mm	10N23MS
9	Stubby Collet, 2.4mm	10N24S
10	Collet Body, 0.5mm	10N29
10	Collet Body, 1.0mm	10N30
10	Collet Body, 1.6mm	10N31
10	Collet Body, 2.4mm	10N32
11	Stubby Collet Body, All Size	17CB20
12	Gas Lens Body, 0.5mm	45V29
12	Gas Lens Body, 1.0mm	45V24
12	Gas Lens Body, 1.6mm	45V25
12	Gas Lens Body, 2.4mm	45V26
13	Large Dia. Gas Lens Body, 1.6mm	45V116
13	Large Dia. Gas Lens Body, 2.4mm	45V64
14	Ceramic Nozzle, 6mm	10N50
14	Ceramic Nozzle, 8mm	10N49
14	Ceramic Nozzle, 10mm	10N48
14	Ceramic Nozzle, 11mm	10N47
14	Ceramic Nozzle, 13mm	10N46

NO.	DESCRIPTION	PART NO.
14	Ceramic Nozzle, 16mm	10N45
14	Ceramic Nozzle, 19mm	10N44
15	Extra Long Ceramic Nozzle, 8mm	10N49L
15	Extra Long Ceramic Nozzle, 10mm	10N48L
15	Extra Long Ceramic Nozzle, 11mm	10N47L
16	Stubby Ceramic Nozzle, 6mm	13N08
16	Stubby Ceramic Nozzle, 8mm	13N09
16	Stubby Ceramic Nozzle, 10mm	13N10
16	Stubby Ceramic Nozzle, 11mm	13N11
16	Stubby Ceramic Nozzle, 13mm	13N12
16	Stubby Ceramic Nozzle, 16mm	13N13
17	Ceramic Nozzle, 6mm	54N18
17	Ceramic Nozzle, 8mm	54N17
17	Ceramic Nozzle, 10mm	54N16
17	Ceramic Nozzle, 11mm	54N15
17	Ceramic Nozzle, 13mm	54N14
17	Ceramic Nozzle, 17mm	54N19
18	Extra Long Ceramic Nozzle, 8mm	54N17L
18	Extra Long Ceramic Nozzle, 10mm	54N16L
18	Extra Long Ceramic Nozzle, 11mm	54N15L
19	Extra Dia. Ceramic Nozzle, 10mm	57N75
19	Extra Dia. Ceramic Nozzle, 13mm	57N74
19	Extra Dia. Ceramic Nozzle, 16mm	53N88
19	Extra Dia. Ceramic Nozzle, 19mm	53N87
20	Switch (With Wire)	
21	Handle	105Z55
22	Cable Assembly	
23	Cable Assembly Cover	
24	Valve Stem	VS-2

**WP-17,WP-17F,WP-17V,WP-17FV Cable Terminations(Cable and Gas Whole)**

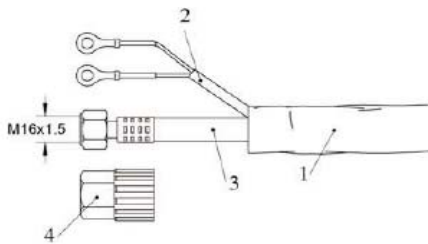

NO.	DESCRIPTION
1	Cable Assembly Cover, For 4m(12.5ft), Rubber/Jean
	Cable Assembly Cover, For 8m(25ft), Rubber/Jean
2	Control Wire
3	Cable 10mm <sup>2</sup> , 4m(12.5ft)
	Cable 10mm <sup>2</sup> , 8m(25ft)
4	Nut Cup(SW19)

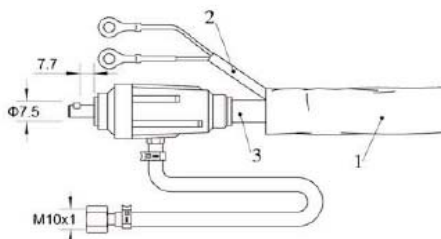

NO.	DESCRIPTION
1	Cable Assembly Cover, For 4m(12.5ft), Rubber/Jean
	Cable Assembly Cover, For 8m(25ft), Rubber/Jean
2	Control Wire
3	Cable 10mm <sup>2</sup> , 4m(12.5ft)
	Cable 10mm <sup>2</sup> , 8m(25ft)
4	Nut Cup(SW19)

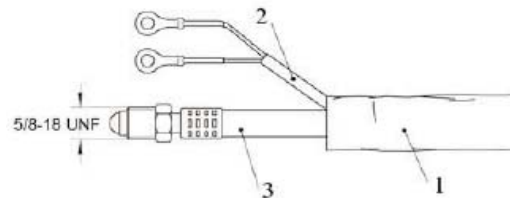

NO.	DESCRIPTION
1	Cable Assembly Cover, For 4m(12.5ft), Rubber/Jean
	Cable Assembly Cover, For 8m(25ft), Rubber/Jean
2	Control Wire
3	Cable 10mm <sup>2</sup> , 4m(12.5ft)
	Cable 10mm <sup>2</sup> , 8m(25ft)

**WP-17,WP-17F,WP-17V,WP-17FV Cable Terminations(Cable and Gas Separate)**

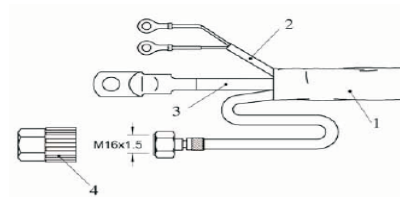

NO.	DESCRIPTION
1	Cable Assembly Cover, For 4m(12.5ft), Rubber/Jean
	Cable Assembly Cover, For 8m(25ft), Rubber/Jean
2	Control Wire
3	Cable 16mm <sup>2</sup> , 4m(12.5ft)
	Cable 16mm <sup>2</sup> , 8m(25ft)
4	Nut Cup(SW19)

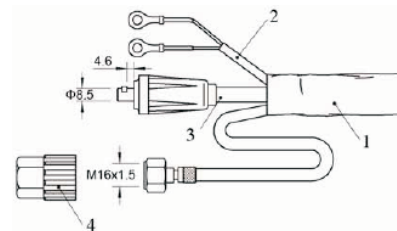

NO.	DESCRIPTION
1	Cable Assembly Cover, For 4m(12.5ft), Rubber/Jean
	Cable Assembly Cover, For 8m(25ft), Rubber/Jean
2	Control Wire
3	Cable 16mm <sup>2</sup> , 4m(12.5ft)
	Cable 16mm <sup>2</sup> , 8m(25ft)
4	Nut Cup(SW19)

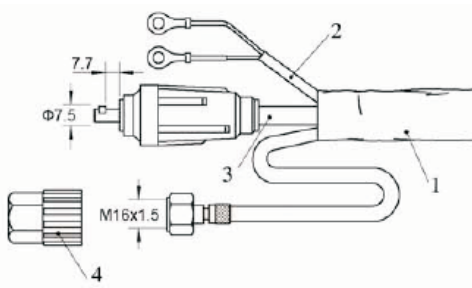

NO.	DESCRIPTION
1	Cable Assembly Cover, For 4m(12.5ft), Rubber/Jean Cable Assembly Cover, For 8m(25ft), Rubber/Jean
2	Control Wire
3	Cable 16mm <sup>2</sup> , 4m(12.5ft) Cable 16mm <sup>2</sup> , 8m(25ft)
4	Nut Cup(SW19)

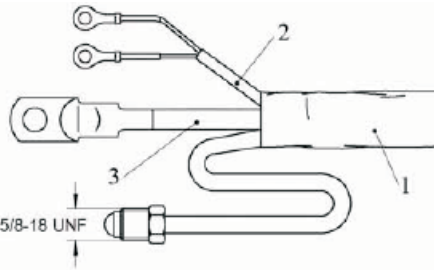

NO.	DESCRIPTION
1	Cable Assembly Cover, For 4m(12.5ft), Rubber/Jean Cable Assembly Cover, For 8m(25ft), Rubber/Jean
2	Control Wire
3	Cable 16mm <sup>2</sup> , 4m(12.5ft) Cable 16mm <sup>2</sup> , 8m(25ft)

Please indicate the length, cable termination, and cable cover type, when ordering complete torch

**WP-18 Series Water Cooled TIG Torch**

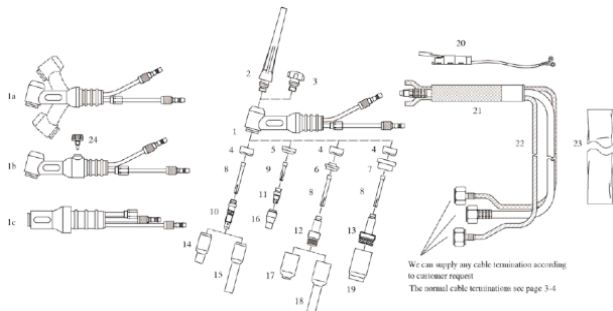

**Technical Data**  
 Rating: 350A DC  
 250AAC  
 Duty Cycle: 100%  
 Electrodes: 0.5~4.0mm

NO.	DESCRIPTION	PART NO.
	WP-18 Torch (Gas and Cable Whole)	WP-18 (4m)
	WP-18 Torch (Gas and Cable Whole)	WP-18 (8m)
1	Torch Body	WP-18
1a	Torch Body (Flexible)	WP-18F
1b	Torch Body (Valve)	WP-18V
1c	Torch Body (Pencil)	WP-18P
2	Long Back Cap	57Y02
3	Short Back Cap	57Y04
4	Gasket	18CG
5	Stubby Gasket	18CG-20
6	Gas Lens Insulator	54N01
7	Large Dia. Gas Lens Insulator	54N63
8	Collet, 0.5mm	10N21
8	Collet, 1.0mm	10N22
8	Collet, 1.6mm	10N23
8	Collet, 2.0mm	10N23M
8	Collet, 2.4mm	10N24
8	Collet, 3.2mm	10N25
9	Stubby Collet, 0.5mm	10N21S
9	Stubby Collet, 1.0mm	10N22S
9	Stubby Collet, 1.6mm	10N23S
9	Stubby Collet, 2.0mm	10N23MS
9	Stubby Collet, 2.4mm	10N24S
9	Stubby Collet, 3.2mm	10N25S
10	Collet Body, 0.5mm	10N29
10	Collet Body, 1.0mm	10N30
10	Collet Body, 1.6mm	10N31
10	Collet Body, 2.4mm	10N32
10	Collet Body, 3.2mm	10N28
11	Stubby Collet Body, All Size	17CB20
12	Gas Lens Body, 0.5mm	45V29
12	Gas Lens Body, 1.0mm	45V24
12	Gas Lens Body, 1.6mm	45V25
12	Gas Lens Body, 2.4mm	45V26
12	Gas Lens Body, 3.2mm	45V27
13	Large Dia. Gas Lens Body, 1.6mm	45V116
13	Large Dia. Gas Lens Body, 2.4mm	45V64
13	Large Dia. Gas Lens Body, 3.2mm	995795
13	Large Dia. Gas Lens Body, 4.0mm	45V63
14	Ceramic Nozzle, 6mm	10N50
14	Ceramic Nozzle, 8mm	10N49
14	Ceramic Nozzle, 10mm	10N48
14	Ceramic Nozzle, 11mm	10N47
14	Ceramic Nozzle, 13mm	10N46
14	Ceramic Nozzle, 16mm	10N45
14	Ceramic Nozzle, 19mm	10N44
15	Extra Long Ceramic Nozzle, 8mm	10N49L
15	Extra Long Ceramic Nozzle, 10mm	10N48L
15	Extra Long Ceramic Nozzle, 11mm	10N47L
16	Stubby Ceramic Nozzle, 6mm	13N08
16	Stubby Ceramic Nozzle, 8mm	13N09
16	Stubby Ceramic Nozzle, 10mm	13N10
16	Stubby Ceramic Nozzle, 11mm	13N11
16	Stubby Ceramic Nozzle, 13mm	13N12
16	Stubby Ceramic Nozzle, 16mm	13N13
17	Ceramic Nozzle, 6mm	54N18
17	Ceramic Nozzle, 8mm	54N17
17	Ceramic Nozzle, 10mm	54N16



NO.	DESCRIPTION	PART NO.
17	Ceramic Nozzle, 11mm	54N15
17	Ceramic Nozzle, 13mm	54N14
17	Ceramic Nozzle, 17mm	54N19
18	Extra Long Ceramic Nozzle, 8mm	54N17L
18	Extra Long Ceramic Nozzle, 10mm	54N16L
18	Extra Long Ceramic Nozzle, 11mm	54N15L
19	Extra Dia. Ceramic Nozzle, 10mm	57N75
19	Extra Dia. Ceramic Nozzle, 13mm	57N74
19	Extra Dia. Ceramic Nozzle, 16mm	53N88
19	Extra Dia. Ceramic Nozzle, 19mm	53N87
20	Switch (With Wire)	
21	Handle	105Z55
22	Cable Assembly	
23	Cable Assembly Cover	
24	Valve Stem	VS-2

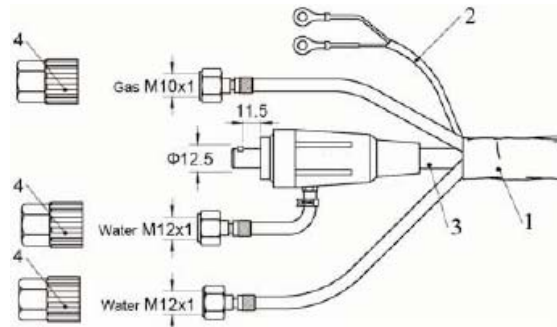

NO.	DESCRIPTION
1	Cable Assembly Cover, For 4m(12.5ft), Rubber/Jean Cable Assembly Cover, For 8m(25ft), Rubber/Jean
2	Control Wire
3	Cable 8mm <sup>2</sup> , 4m(12.5ft) Cable 8mm <sup>2</sup> , 8m(25ft) Nut Cup(SW17)

**WP-18,WP-18F,WP-18V,WP-18P  
Cable Terminations**

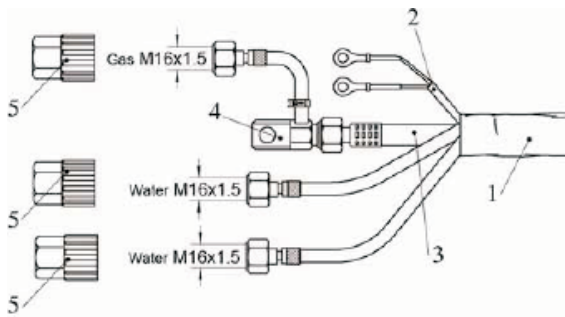

NO.	DESCRIPTION
1	Cable Assembly Cover, For 4m(12.5ft), Rubber/Jean Cable Assembly Cover, For 8m(25ft), Rubber/Jean
2	Control Wire
3	Cable 8mm <sup>2</sup> , 4m(12.5ft) Cable 8mm <sup>2</sup> , 8m(25ft)
4	Cable Adaptor
5	Nut Cup(SW19)

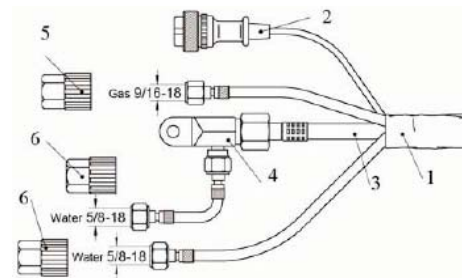

NO.	DESCRIPTION
1	Cable Assembly Cover, For 4m(12.5ft), Rubber/Jean Cable Assembly Cover, For 8m(25ft), Rubber/Jean
2	Plug 2-Pin, Panasonic
3	Cable 8mm <sup>2</sup> , 4m(12.5ft) Cable 8mm <sup>2</sup> , 8m(25ft)
4	Cable Adaptor
5	Nut Cup(SW17)
6	Nut Cup(SW19)

Please indicate the length, cable termination, and cable cover type, when ordering complete torch

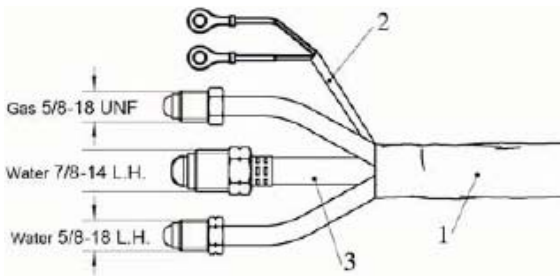

NO.	DESCRIPTION
1	Cable Assembly Cover, For 4m(12.5ft), Rubber/Jean Cable Assembly Cover, For 8m(25ft), Rubber/Jean
2	Control Wire
3	Cable 8mm <sup>2</sup> , 4m(12.5ft) Cable 8mm <sup>2</sup> , 8m(25ft)

**WP-20 Series Water Cooled TIG Torch**

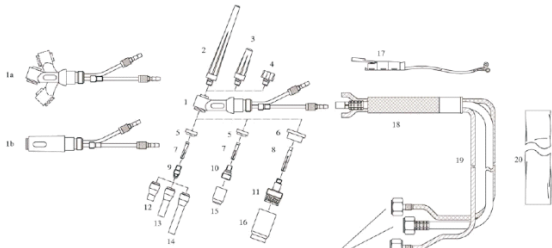

**Technical Data**  
 Rating: 250A DC  
 175AAC  
 Duty Cycle: 100%  
 Electrodes: 0.5~4.0mm

We can supply any cable termination according to customer request  
 The normal cable terminations see page 3-4

NO.	DESCRIPTION	PART NO.
	WP-20 Torch	WP-20 (4m)
	WP-20 Torch	WP-20 (8m)
	Torch Body	WP-20
1	Torch Body (Flexible)	WP-20F
1b	Torch Body (Pencil)	WP-20P
2	Long Back Cap	41V24
3	Medium Back Cap	41V35
4	Short Back Cap	41V33
5	Gasket	598882
6	Large Dia. Gas Lens Insulator	54N63-20
7	Collet, 0.5mm	13N20
7	Collet, 1.0mm	13N21
7	Collet, 1.6mm	13N22
7	Collet, 2.0mm	13N22M
7	Collet, 2.4mm	13N23
7	Collet, 3.2mm	13N24
8	Large Dia. Gas Lens Collet, 0.5mm	13N20L
8	Large Dia. Gas Lens Collet, 1.0mm	13N21L
8	Large Dia. Gas Lens Collet, 1.6mm	13N22L
8	Large Dia. Gas Lens Collet, 2.4mm	13N23L
8	Large Dia. Gas Lens Collet, 3.2mm	13N24L
9	Collet Body, 0.5mm	13N25
9	Collet Body, 1.0mm	13N26
9	Collet Body, 1.6mm	13N27
9	Collet Body, 2.0mm	13N27M
9	Collet Body, 2.4mm	13N28
9	Collet Body, 3.2mm	13N29
10	Gas Lens Body, 0.5mm	45V41
10	Gas Lens Body, 1.0mm	45V42
10	Gas Lens Body, 1.6mm	45V43
10	Gas Lens Body, 2.0mm	45V43M
10	Gas Lens Body, 2.4mm	45V44
10	Gas Lens Body, 3.2mm	45V45
11	Large Dia. Gas Lens Body	45V0204S
11	Large Dia. Gas Lens Body, 1.6mm	45V116S
11	Large Dia. Gas Lens Body, 2.4mm	45V64S
11	Large Dia. Gas Lens Body, 3.2mm	995795
12	Ceramic Nozzle, 6mm	13N08
12	Ceramic Nozzle, 8mm	13N09
12	Ceramic Nozzle, 10mm	13N10
12	Ceramic Nozzle, 11mm	13N11
12	Ceramic Nozzle, 13mm	13N12
12	Ceramic Nozzle, 16mm	13N13
13	Long Ceramic Nozzle, 5mm	796F70

NO.	DESCRIPTION	PART NO.
13	Long Ceramic Nozzle	796F71, 6mm
13	Long Ceramic Nozzle	796F72, 8mm
13	Long Ceramic Nozzle	796F73, 10mm
14	Extra Long Ceramic Nozzle	796F74, 5mm
14	Extra Long Ceramic Nozzle	796F75, 6mm
14	Extra Long Ceramic Nozzle	796F76, 8mm
14	Extra Long Ceramic Nozzle	796F77, 10mm
15	Ceramic Nozzle	53N58, 6mm
15	Ceramic Nozzle	53N59, 8mm
15	Ceramic Nozzle	53N60, 10mm
15	Ceramic Nozzle	53N61, 11mm
15	Ceramic Nozzle	53N61S, 13mm
16	Extra Dia. Ceramic Nozzle	57N75, 10mm
16	Extra Dia. Ceramic Nozzle	57N74, 13mm
16	Extra Dia. Ceramic Nozzle	53N88, 16mm
16	Extra Dia. Ceramic Nozzle	53N87, 19mm
17	Switch (With Wire)	
18	Handle	105Z55
19	Cable Assembly	
20	Cable Assembly Cover	

**WP-20,WP-20F,WP-20P Cable Terminations**

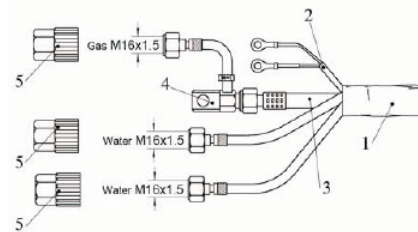

NO.	DESCRIPTION
1	Cable Assembly Cover, For 4m(12.5ft), Rubber/Jean Cable Assembly Cover, For 8m(25ft), Rubber/Jean
2	Control Wire
3	Cable 4mm <sup>2</sup> , 4m(12.5ft) Cable 4mm <sup>2</sup> , 8m(25ft)
4	Cable Adaptor
5	Nut Cup(SW19)

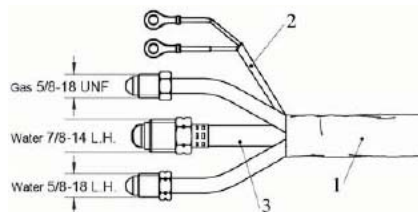

NO.	DESCRIPTION
1	Cable Assembly Cover, For 4m(12.5ft), Rubber/Jean Cable Assembly Cover, For 8m(25ft), Rubber/Jean
2	Control Wire
3	Cable 4mm <sup>2</sup> , 4m(12.5ft) Cable 4mm <sup>2</sup> , 8m(25ft)

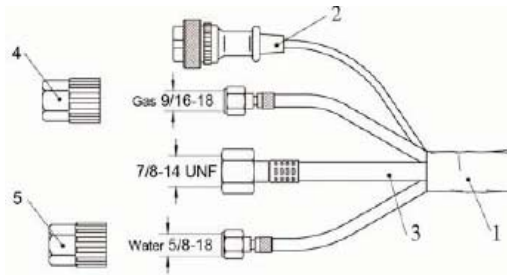

NO.	DESCRIPTION
1	Cable Assembly Cover, For 4m(12.5ft), Rubber/Jean Cable Assembly Cover, For 8m(25ft), Rubber/Jean
2	Plug 2-Pin, Panasonic
3	Cable 4mm <sup>2</sup> , 4m(12.5ft) Cable 4mm <sup>2</sup> , 8m(25ft)
4	Nut Cup(SW17)
5	Nut Cup(SW19)

Please indicate the length, cable termination, and cable cover type, when ordering complete torch

**WP-26 Series Air Cooled TIG Torch**

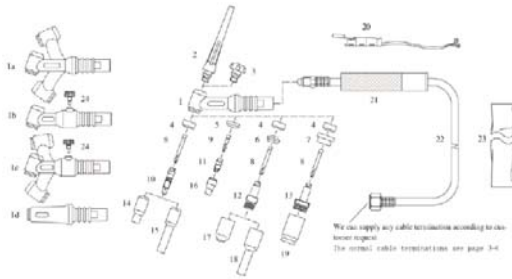

**Technical Data**  
 Rating: 250A DC  
 160AAC  
 Duty Cycle: 60%  
 Electrodes: 0.5-3.2mm

NO.	DESCRIPTION	PART NO.
	WP-26 Torch (Gas and Cable Whole)	WP-26-1 (4m)
	WP-26 Torch (Gas and Cable Whole)	WP-26-1 (8m)
	WP-26 Torch (Gas and Cable Separate)	WP-26-2 (4m)
	WP-26 Torch (Gas and Cable Separate)	WP-26-2 (8m)
1	Torch Body	WP-26
1a	Torch Body (Flexible)	WP-26F
1b	Torch Body (Valve)	WP-26V
1c	Torch Body (Flexible and Valve)	WP-26FV
1d	Torch Body (Pencil)	WP-26P
2	Long Back Cap	57Y02
3	Short Back Cap	57Y04
4	Gasket	18CG
5	Stubby Gasket	18CG-20
6	Gas Lens Insulator	54N01
7	Large Dia. Gas Lens Insulator	54N63
8	Collet, 0.5mm	10N21
8	Collet, 1.0mm	10N22
8	Collet, 1.6mm	10N23

NO.	DESCRIPTION	PART NO.
8	Collet, 2.0mm	10N23M
8	Collet, 2.4mm	10N24
8	Collet, 3.2mm	10N25
9	Subby Collet, 0.5mm	10N21S
9	Subby Collet, 1.0mm	10N22S
9	Subby Collet, 1.6mm	10N23S
9	Subby Collet, 2.0mm	10N23MS
9	Subby Collet, 2.4mm	10N24S
9	Subby Collet, 3.2mm	13N25S
10	Collet Body, 0.5mm	10N29
10	Collet Body, 1.0mm	10N30
10	Collet Body, 1.6mm	10N31
10	Collet Body, 2.4mm	10N32
10	Collet Body, 3.2mm	10N28
11	Stubby Collet Body, All Size	17CB20
12	Gas Lens Body, 0.5mm	45V29
12	Gas Lens Body, 1.0mm	45V24
12	Gas Lens Body, 1.6mm	45V25
12	Gas Lens Body, 2.4mm	45V26
12	Gas Lens Body, 3.2mm	45V27
13	Large Dia. Gas Lens Body, 1.6mm	45V116
13	Large Dia. Gas Lens Body, 2.4mm	45V64
13	Large Dia. Gas Lens Body, 3.2mm	995795
13	Large Dia. Gas Lens Body, 4.0mm	45V63
14	Ceramic Nozzle, 6mm	10N50
14	Ceramic Nozzle, 8mm	10N49
14	Ceramic Nozzle, 10mm	10N48
14	Ceramic Nozzle, 11mm	10N47
14	Ceramic Nozzle, 13mm	10N46
14	Ceramic Nozzle, 16mm	10N45
14	Ceramic Nozzle, 19mm	10N44
15	Extra Long Ceramic Nozzle, 8mm	10N49L
15	Extra Long Ceramic Nozzle, 10mm	10N48L
15	Extra Long Ceramic Nozzle, 11mm	10N47L
16	Short Ceramic Nozzle, 6mm	13N08
16	Short Ceramic Nozzle, 8mm	13N09
16	Short Ceramic Nozzle, 10mm	13N10
16	Short Ceramic Nozzle, 11mm	13N11
16	Short Ceramic Nozzle, 13mm	13N12
16	Short Ceramic Nozzle, 16mm	13N13
17	Ceramic Nozzle, 6mm	54N18
17	Ceramic Nozzle, 8mm	54N17
17	Ceramic Nozzle, 10mm	54N16
17	Ceramic Nozzle, 11mm	54N15
17	Ceramic Nozzle, 13mm	54N14
17	Ceramic Nozzle, 18mm	54N19
18	Extra Long Lava Nozzle, 8mm	54N17L
18	Extra Long Lava Nozzle, 10mm	54N16L
18	Extra Long Lava Nozzle, 11mm	54N15L
19	Extra Dia. Cermic Nozzle, 10mm	57N75
19	Extra Dia. Cermic Nozzle, 13mm	57N74
19	Extra Dia. Cermic Nozzle, 16mm	53N88
19	Extra Dia. Cermic Nozzle, 19mm	53N87
20	Switch(with wire)	
21	Handle	85WP13
22	Cable Assembly	
23	Cable Assembly Cover	
24	Valve Stem	VS-1



**WP26,WP-26F,WP-26V,WP-26FV,WP-26P Cable Terminations(Cable and Gas Whole)**

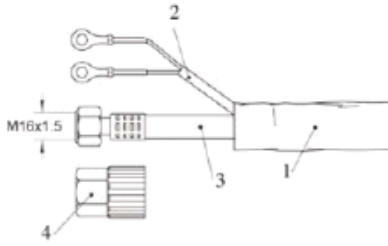

NO.	DESCRIPTION
1	Cable Assembly Cover, For 4m(12.5ft), Rubber/Jean Cable Assembly Cover, For 8m(25ft), Rubber/Jean
2	Control Wire
3	Cable 14mm <sup>2</sup> , 4m(12.5ft) Cable 14mm <sup>2</sup> , 8m(25ft)
4	Nut Cup(SW19)

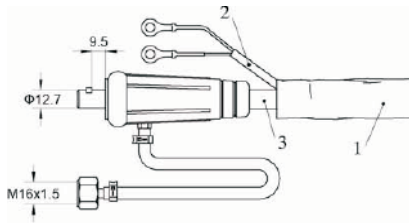

NO.	DESCRIPTION
1	Cable Assembly Cover, For 4m(12.5ft), Rubber/Jean Cable Assembly Cover, For 8m(25ft), Rubber/Jean
2	Control Wire
3	Cable 14mm <sup>2</sup> , 4m(12.5ft) Cable 14mm <sup>2</sup> , 8m(25ft)

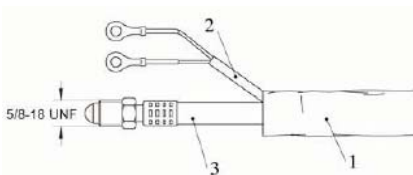

NO.	DESCRIPTION
1	Cable Assembly Cover, For 4m(12.5ft), Rubber/Jean Cable Assembly Cover, For 8m(25ft), Rubber/Jean
2	Control Wire
3	Cable 14mm <sup>2</sup> , 4m(12.5ft) Cable 14mm <sup>2</sup> , 8m(25ft)

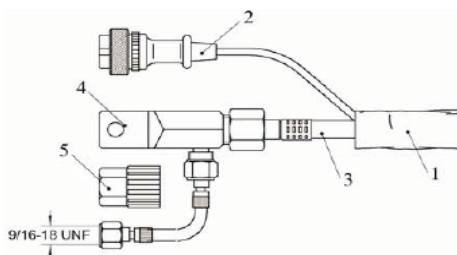

NO.	DESCRIPTION
1	Cable Assembly Cover, For 4m(12.5ft), Rubber/Jean Cable Assembly Cover, For 8m(25ft), Rubber/Jean
2	Plug 2-Pin, Panasonic
3	Cable 14mm <sup>2</sup> , 4m(12.5ft) Cable 14mm <sup>2</sup> , 8m(25ft)
4	Cable Adapter
5	Nut Cup(SW17)

**WP26,WP-26F,WP-26V,WP-26FV,WP-26P Cable Terminations(Cable and Gas Separate)**

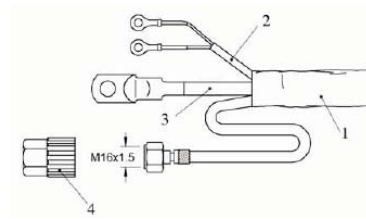

NO.	DESCRIPTION
1	Cable Assembly Cover, For 4m(12.5ft), Rubber/Jean Cable Assembly Cover, For 8m(25ft), Rubber/Jean
2	Control Wire
3	Cable 25mm <sup>2</sup> , 4m(12.5ft) Cable 25mm <sup>2</sup> , 8m(25ft)
4	Nut Cup(SW19)

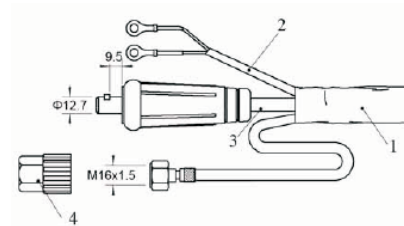

NO.	DESCRIPTION
1	Cable Assembly Cover, For 4m(12.5ft), Rubber/Jean Cable Assembly Cover, For 8m(25ft), Rubber/Jean
2	Control Wire
3	Cable 25mm <sup>2</sup> , 4m(12.5ft) Cable 25mm <sup>2</sup> , 8m(25ft)
4	Nut Cup(SW19)

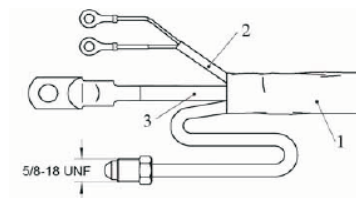

NO.	DESCRIPTION
1	Cable Assembly Cover, For 4m(12.5ft), Rubber/Jean Cable Assembly Cover, For 8m(25ft), Rubber/Jean
2	Control Wire
3	Cable 25mm <sup>2</sup> , 4m(12.5ft) Cable 25mm <sup>2</sup> , 8m(25ft)

Please indicate the length, cable termination, and cable cover type, when ordering complete torch

**WP-27 Series Water Cooled TIG Torch**

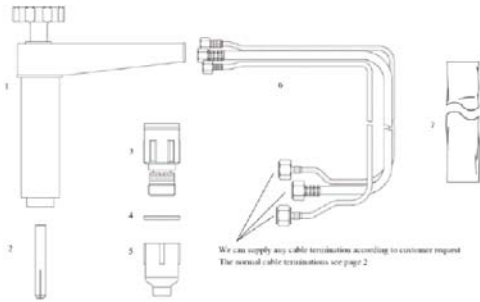

**Technical Data**  
 Rating: 500A DC  
 Duty Cycle: 100%  
 Electrodes: 1.0-6.4mm

NO.	DESCRIPTION	PART NO.
	WP-27 Torch (Gas and Cable Whole)	WP-27-1 (4m)
	WP-27 Long Torch (Gas and Cable Whole)	WP-27-1L (4m)
	WP-27 Torch (Gas and Cable Separate)	WP-27-2 (8m)
	WP-27 Long Torch (Gas and Cable Separate)	WP-27-2L(8m)
1	Torch Body (8" Long, Include Shaft and Boot)	WP-27
	Torch Body (20" Long, Include Shaft and Boot)	WP-27(long)
2	Collet, 1.6mm	57N46
2	Collet, 2.4mm	57N47
2	Collet, 3.2mm	57N48
2	Collet, 4.0mm	57N49
3	Gas Lens, 1.6mm	49V23
3	Gas Lens, 2.4mm	49V24
3	Gas Lens, 3.2mm	49V25
3	Gas Lens, 4.0mm	49V26
4	Gasket	49V26
5	Ceramic Nozzle, 8#	57N56
5	Ceramic Nozzle, 10#	57N74
5	Ceramic Nozzle, 12#	57N78
5	Ceramic Nozzle, 10#	57N77
5	Ceramic Nozzle, 12#	57N88
6	Cable Assembly	53N88
7	Cable Assembly Cover	53N87

**WP27 Cable Terminations**

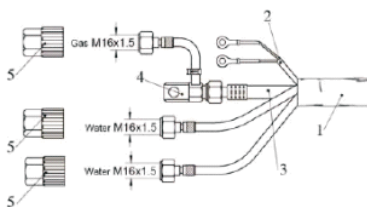

NO.	DESCRIPTION
1	Cable Assembly Cover, For 4m(12.5ft), Rubber/Jean
	Cable Assembly Cover, For 8m(25ft), Rubber/Jean
2	Control Wire
3	Cable 12mm <sup>2</sup> , 4m(12.5ft)
	Cable 12mm <sup>2</sup> , 8m(25ft)
4	Cable Adapter
5	Nut Cup(SW19)

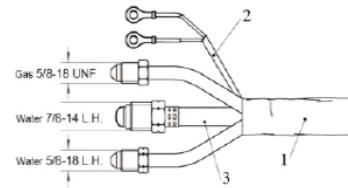

NO.	DESCRIPTION
1	Cable Assembly Cover, For 4m(12.5ft), Rubber/Jean
	Cable Assembly Cover, For 8m(25ft), Rubber/Jean
2	Control Wire
3	Cable 12mm <sup>2</sup> , 4m(12.5ft)
	Cable 12mm <sup>2</sup> , 8m(25ft)

Please indicate the length, cable termination, and cable cover type, when ordering complete torch

**Other TIG Torches      Control Wire Plugs**

**Description**  
 Kemppi TTK350W Water Cooled TIG Torch  
 Rating: 300A DC / 250AAC  
 Duty Cycle: 100%  
 Electrode: 1.0-4.0mm



**Description**  
 Panasonic YT-208 Air Cooled TIG Torch  
 Rating: 200A DC / 160AAC  
 Duty Cycle: 50%  
 Electrode: 1.0-3.2mm



**Description**  
 LT-18P Water Cooled TIG Torch  
 Rating: 315A DC  
 Duty Cycle: 100%  
 Electrode: 1.0-4.0mm



**Description**  
 WP-24 Air Cooled TIG Torch  
 Rating: 80A DC / 50AAC  
 Duty Cycle: 60%  
 Electrode: 1.0-1.6mm



**Description**  
 WP-25 Air Cooled TIG Torch  
 Rating: 120A DC / 80AAC  
 Duty Cycle: 60%  
 Electrode: 1.0-2.4mm



**Description**  
 Panasonic YT-158 Air Cooled TIG Torch  
 Rating: 150A DC / 130AAC  
 Duty Cycle: 60%  
 Electrode: 0.5-2.4mm

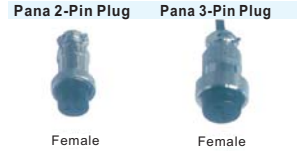

**Description**  
 Panasonic YT-308 Water Cooled TIG Torch  
 Rating: 300A DC / 260AAC  
 Duty Cycle: 100%  
 Electrode: 1.0-4.0mm



**Description**  
 LT-26P Air Cooled TIG Torch  
 Rating: 250A DC  
 Duty Cycle: 60%  
 Electrode: 1.0-3.2mm

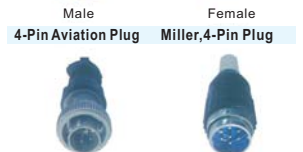

**Description**  
 WP-24W Water Cooled TIG Torch  
 Rating: 180A DC / 150AAC  
 Duty Cycle: 100%  
 Electrode: 1.0-2.4mm



**Description**  
 WP-25W Water Cooled TIG Torch  
 Rating: 200A DC / 150AAC  
 Duty Cycle: 100%  
 Electrode: 1.0-3.2mm